

# Axelent X-Protect

Pedestrian + Impact

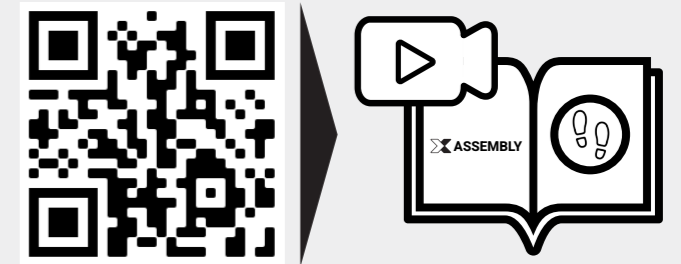
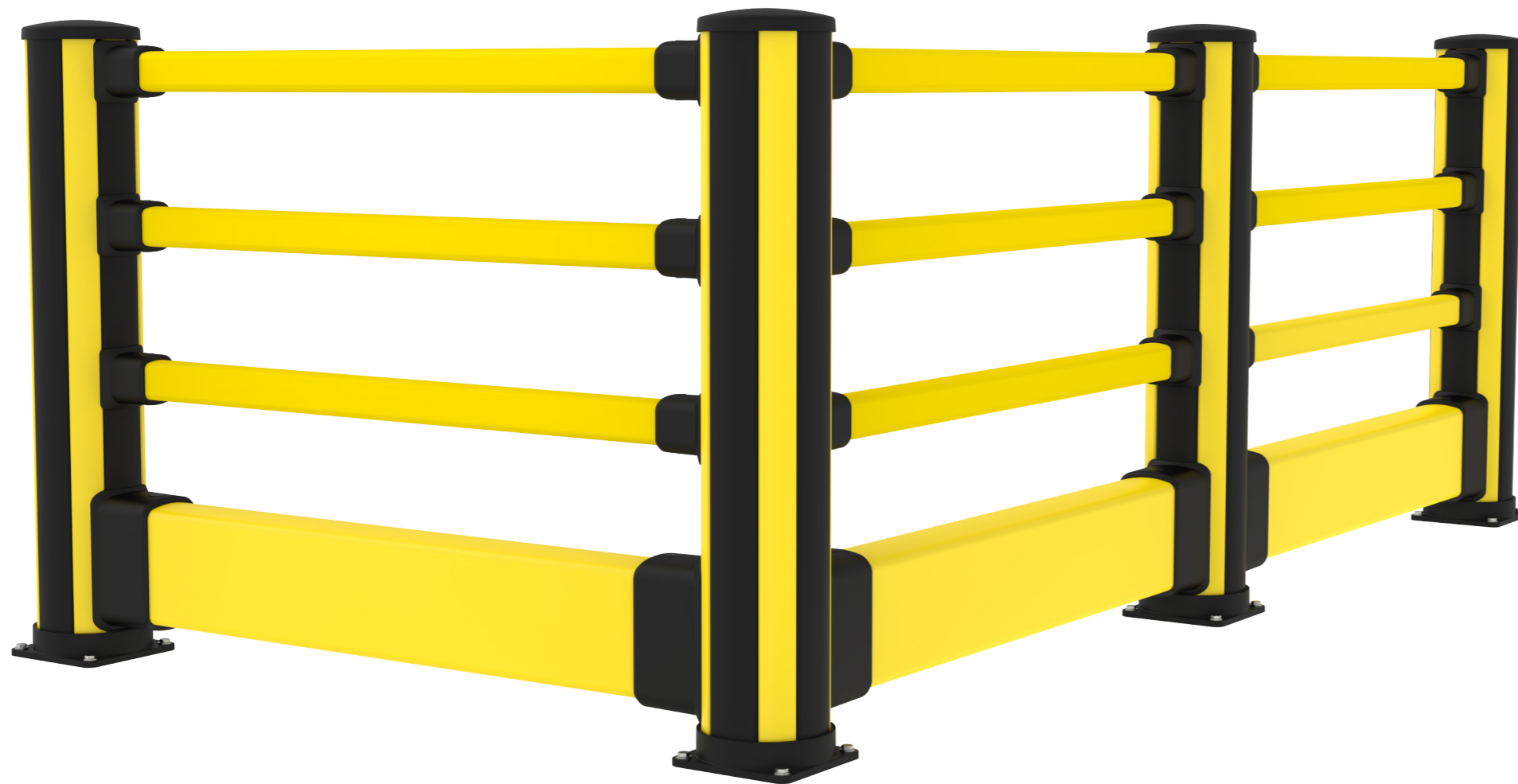

**AXELENT AB** • BOX 1  
KÄVSJÖVÄGEN 17 • SE-335 73  
HILLERSTORP • SWEDEN

TEL +46 (0)370-37 37 30  
INFO@AXELENT.SE  
WWW.AXELENT.COM



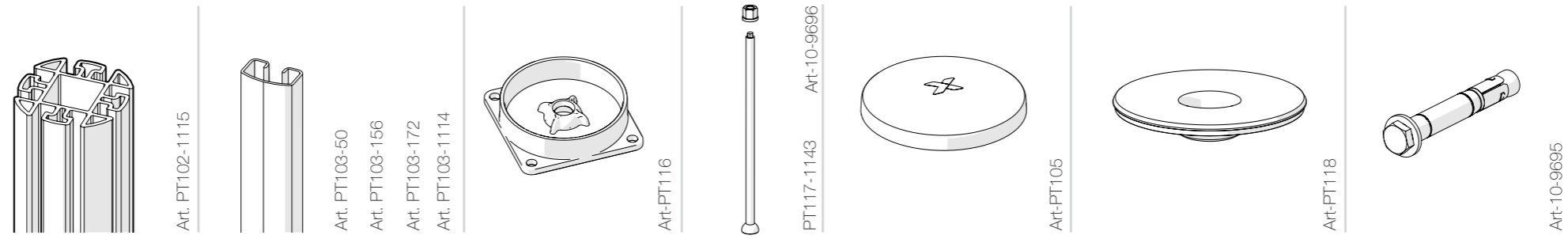

**BCE0-116-I1P3**  
**BCM0-116-I1P3**  
**BCC0-116-I1P3**

1		1	1	2	3	1+1	1	1	1	4
1		2	2	4	2	1+1	1	1	1	4
1		2	2	4	2	1+1	1	1	1	4

**CCS9-000-00P1**

3	3	3
6	6	6
6	6	6

**CCS9-000-I100**

1	1	1
2	2	2
2	2	2

**BCE0-116-I1P3**  
**BCM0-116-I1P3**  
**BCC0-116-I1P3**

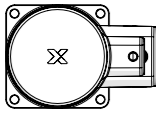

**BCE0-116-I1P3**

	CCS9-000-00P1		
	PT103-172		
	CCS9-000-00P1		
PT103-1114	PT103-172	PT103-1114	PT103-1114
	CCS9-000-00P1		
	PT103-156		
	CCS9-000-I100		
	PT103-050		

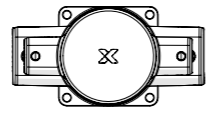

**BCM0-116-I1P3**

	CCS9-000-00P1		CCS9-000-00P1
	PT103-172		PT103-172
	CCS9-000-00P1		CCS9-000-00P1
PT103-1114	PT103-172	PT103-1114	PT103-172
	CCS9-000-00P1		CCS9-000-00P1
	PT103-156		PT103-156
	CCS9-000-I100		CCS9-000-I100
	PT103-050		PT103-050

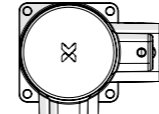

**BCC0-116-I1P3**

		CCS9-000-00P1	CCS9-000-00P1
		PT103-172	PT103-172
		CCS9-000-00P1	CCS9-000-00P1
PT103-1114	PT103-1114	PT103-172	PT103-172
		CCS9-000-00P1	CCS9-000-00P1
		PT103-156	PT103-156
		CCS9-000-I100	CCS9-000-I100
		PT103-050	PT103-050

**RCP1-XXX-XXXX**  
 (RC1-length-centre to centre)

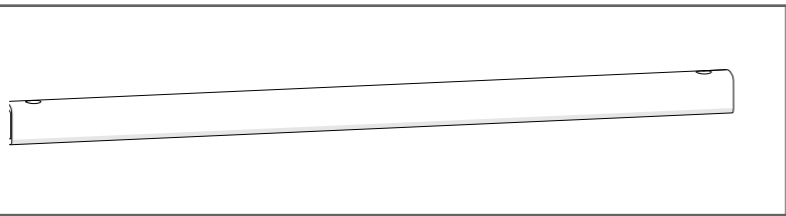

**RCI1-XXX-XXXX**  
 (RC1-length-centre to centre)



