

# Axeleent X-Protect

Pedestrian

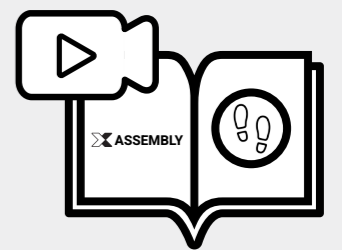
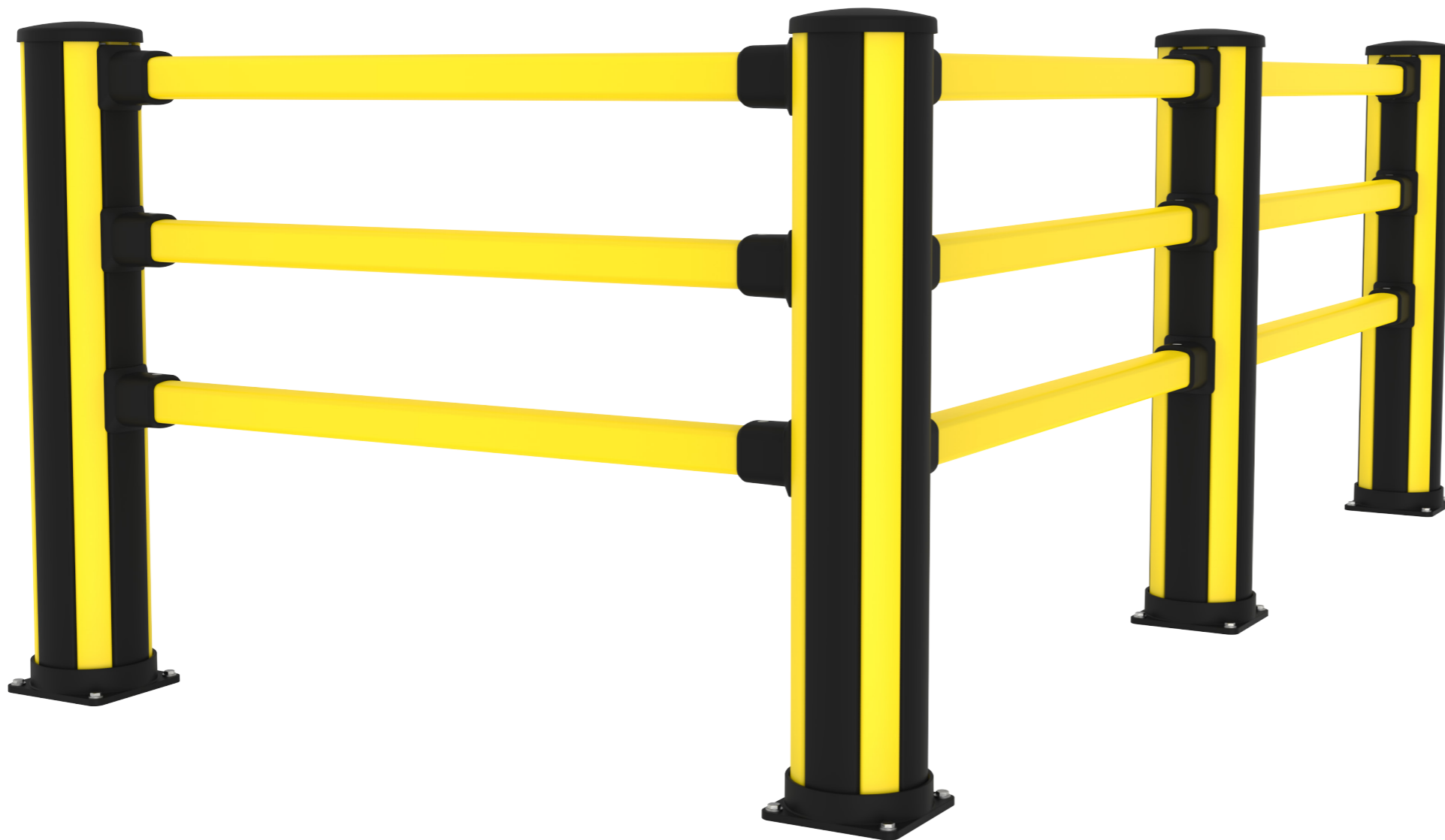

**AXELENT AB** • BOX 1  
KÄVSJÖVÄGEN 17 • SE-335 73  
HILLERSTORP • SWEDEN

TEL +46 (0)370-37 37 30  
INFO@AXELENT.SE  
WWW.AXELENT.COM



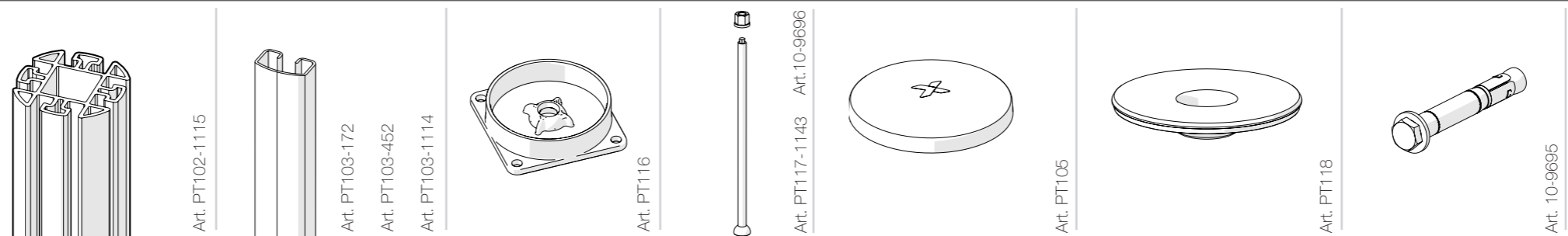

**BCE1-116-00P3**  
**BCM1-116-00P3**  
**BCC1-116-00P3**

1	3	1	2	1	1+1	1	1	4
1	2	4	2	1	1+1	1	1	4
1	2	4	2	1	1+1	1	1	4

**CCS9-000-00P1**

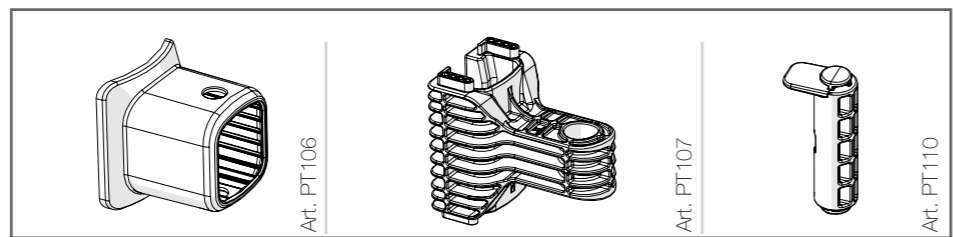

**BCE1-116-00P3**  
**BCM1-116-00P3**  
**BCC1-116-00P3**

6	3	3
6	6	6
6	6	6

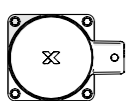

**BCE1-116-00P3**

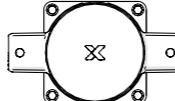

**BCM1-116-00P3**

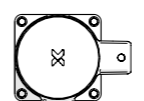

**BCC1-116-00P3**

	CCS9-000-00P1			
	PT103-172			
	CCS9-000-00P1			
PT103-1114	PT103-172	PT103-1114	PT103-1114	
	CCS9-000-00P1			
	PT103-452			

	CCS9-000-00P1		CCS9-000-00P1	
	PT103-172		PT103-172	
	CCS9-000-00P1		CCS9-000-00P1	
PT103-1114	PT103-172	PT103-1114	PT103-172	
	CCS9-000-00P1		CCS9-000-00P1	
	PT103-452		PT103-452	

			CCS9-000-00P1	CCS9-000-00P1
			PT103-172	PT103-172
			CCS9-000-00P1	CCS9-000-00P1
PT103-1114	PT103-1114	PT103-172	PT103-172	
		CCS9-000-00P1	CCS9-000-00P1	
		PT103-452	PT103-452	

**RC11-XXX-XXXX**  
 (RC11-length-centre to centre)

