

Related Products: Multi-tube Holder **TM Series**

RoHS

- Easy arrangement of tubing
Easy tube insertion and firm fixation
- Possible to separate options depending on number of connection tubes
- Use of flame resistant resin (Equivalent to UL-94 standard V-0)



Applicable Tubing

Tubing material	Nylon, Soft nylon, Polyurethane, other soft plastic tubing
Tubing O.D.	Ø 4, Ø 6, Ø 8, Ø 10, Ø 12

Model

Applicable tubing O.D. (mm)	Model	No. of connecting tubes (Max.)		
		6	8	12
4	TM-04			●
6	TM-06			●
8	TM-08		●	
10	TM-10	●		
12	TM-12	●		

Specifications

Ambient temperature	-20 to 60 °C		
Material	Flame resistant polypropylene (Equivalent to UL-94 standard V-0)		
Colour	Black		
Accessory	For mounting Cross recessed head countersunk tapping screw (Zinc chromated)		
	Model	Size (Nominal x Length)	No. of tubings
	TM-04	2 x 6	4
	TM-06	2.6 x 8	
	TM-08		
	TM-10		
TM-12	3 x 8		

Dimensions: Multi-tube Holder

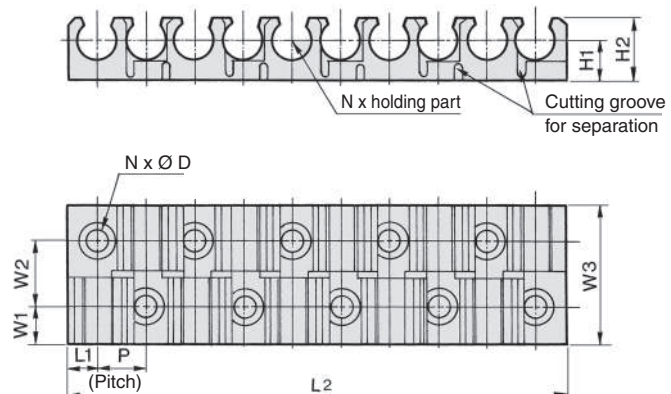

Applicable tubing O.D. [mm]	Model	N (No. of holding parts)	P	L ₁	L ₂	W ₁	W ₂	W ₃	H ₁	H ₂	Ø D	Mounting screw (Nominal x Length)
4	TM-04	12	6	3.25	72.5	4.5	8	17	5	7.5	2.2	2 x 6
6	TM-06	12	7.5	4.5	91.5	5.5	10	21	6.5	10	2.8	2.6 x 8
8	TM-08	8	9.5	5.5	77.5	6	11	23	7.5	12	2.8	2.6 x 8
10	TM-10	6	12.5	7.5	77.5	6.5	12	25	8.8	14.3	3.2	3 x 8
12	TM-12	6	15	9	93	6.5	12	25	9.8	16.3	3.2	3 x 8

How to Use

⚠ Caution

1. Cut the multi-tube holder depending on number of tubes to be connected.

<Cutting method>

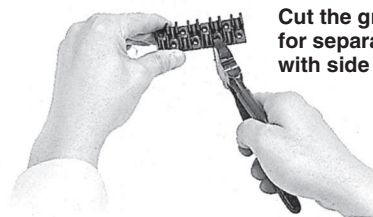

Cut the groove for separation with side cutters.

2. Install the multi-tube holder to the equipment with cross-recessed head, countersunk tapping screw.
3. Lay the tube across the gripper and push on the tube.
4. For removing the tubes, pull up the tubes from the gripper.



EMC-TM/TMA/TK/TKS/TG-01Aa-UK

Related Products: Multi-holder **TMA Series**



- Can be used to secure the KE□ series exhaust valve with One-touch fitting.
- One-touch fitting New KQ2, union tee, elbow, and straight can also be secured.
- Depending on the number of holders required, they can be separated as desired. (Align the cutter with the cutting groove and cut the holder.)

Specifications

Ambient temperature	-20 to 60 °C (No freezing)
Material	Flame resistant polypropylene (Equivalent to UL-94 standard V-0)
Colour	Black

Model

Model	N (Stations)	Applicable exhaust valve	Applicable One-touch fitting		
			Union tee	Union elbow	Straight union
TMA-04	10	—	KQ2T06-00A	KQ2L06-00A	KQ2H06-00A
TMA-06	8	KEA06	KQ2T08-00A	KQ2L08-00A	KQ2H08-00A
		KEB06			
TMA-08	8	KEA08	KQ2T10-00A	KQ2L10-00A	KQ2H10-00A
		KEB08			
		KEC-02			
TMA-10	6	KEA10	KQ2T12-00A	KQ2L12-00A	KQ2H12-00A
		KEB10			
TMA-12	6	KEA12	—	—	—
		KEB12			
		KEC-03			



Dimensions: Multi-holder

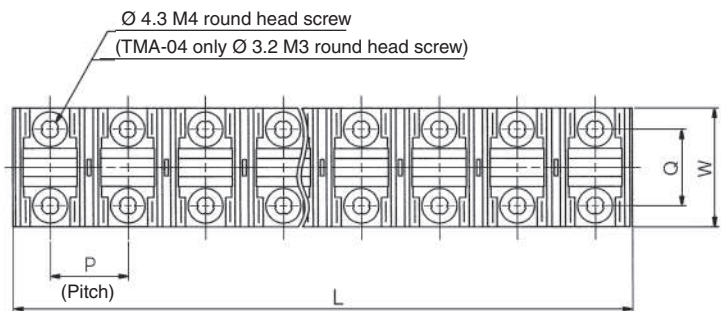
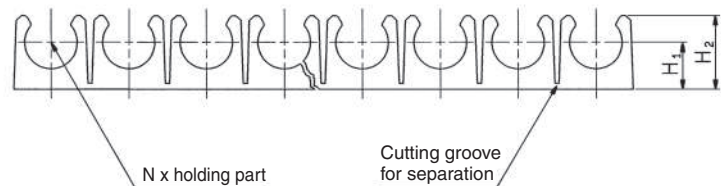

Model	P	L	W	H ₁	H ₂	Q
TMA-04	16.1	160.1	26	10.2	15.5	17.5
TMA-06	19	151	29	11.4	17.9	18.6
TMA-08	21.7	172.5	31.8	12.6	20.3	18.6
TMA-10	25.4	151.2	35	15	24.3	22
TMA-12	28.1	167.3	37	16.2	26.7	22

Related Products: Tube Cutter *TK Series*



Tube Cutter: TK-6
Perpendicular cutting
Air leakage due to cutting failure reduced
Blade is replaceable
Safety lock contained

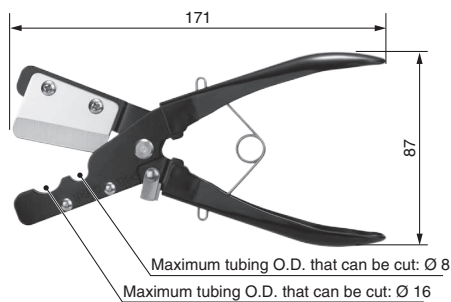

Note) Do not use it to cut the metallic materials such as electric wires.

Model	TK-6
Applicable tubing material	Nylon, Soft nylon, Polyurethane, and other soft plastic tubing
Maximum tubing O.D. that can be cut	16 mm or less
Weight	130 g
Replacement blade part no.	TK6KAEHA (5 replacement blades + 2 mounting screws)

Tube Cutter: TK-1
Perpendicular cutting
Reduced operating force
Safety lock contained

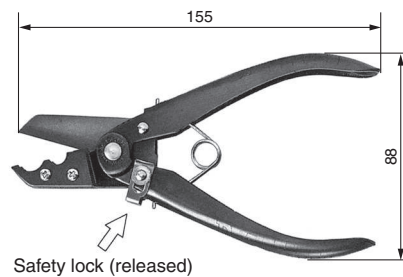

Note) Do not use it to cut the metallic materials such as electric wires.

Model	TK-1
Applicable tubing material	Nylon, Soft nylon, Polyurethane, and other soft plastic tubing
Applicable tubing O.D.	13 mm or less
Weight	140 g

Tube Cutter: TK-2
Possible to cut a tube up to 18 mm

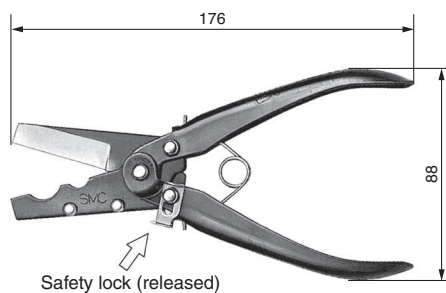

Note) Do not use it to cut the metallic materials such as electric wires.

Model	TK-2
Applicable tubing material	Nylon, Soft nylon, Polyurethane, and other soft plastic tubing
Applicable tubing O.D.	18 mm or less
Weight	140 g

Tube Cutter: TK-3 (Useful type)
Safety lock contained
Blade is replaceable

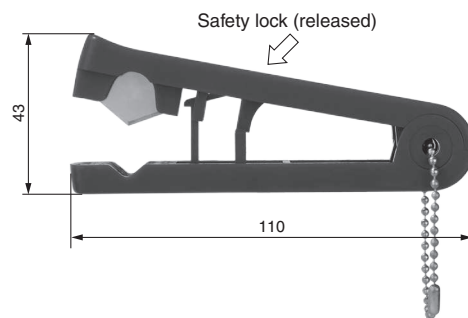

Note) Do not use it to cut the metallic materials such as electric wires.

Model	TK-3
Applicable tubing material	Nylon, Soft nylon, Polyurethane, and other soft plastic tubing
Applicable tubing O.D.	12 mm or less
Weight	32 g
Replacement blade part no.	IN-461-4 (10 replacement blades)

Related Products: Double Layer Tube Stripper **TKS Series**



Allows easy stripping of the outer layer from double layer tubes.

Even the double layer polyurethane tubing (TRBU series), which is highly adhesive to the external layer can be stripped easily.

Blade is replaceable

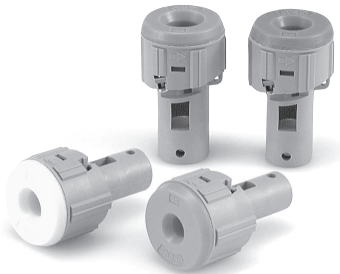

Model

Model	Tip colour	Applicable tubing *	Replacement blade part no.	Dimensions [mm]			Weight [g]
				D1	D2	L	
TKS-06	Orange	TRB0604, TRBU0604	TKS-DPH0071 (10 replacement blades)	35	16	58	45
TKS-08	Yellow	TRB0806, TRBU0805			18		
TKS-10	Blue	TRB1075, TRBU1065			20	62	
TKS-12	Green	TRB1209, TRBU1208			22		

* Inner tubing material/TRB: Nylon, TRBU: Polyurethane

Dimensions

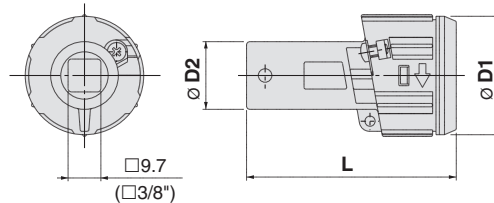

Able to strip without damaging the inner tubing

The outer tube can be stripped without damaging the inner tube because a pawl is inserted between the inner and outer tube layers.

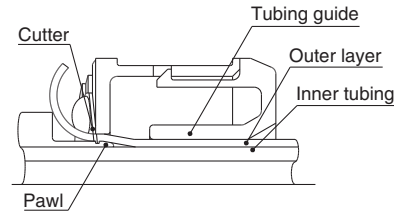

Can be attached to tools

Stripping work can be automated by attaching an air driver, etc. with it.

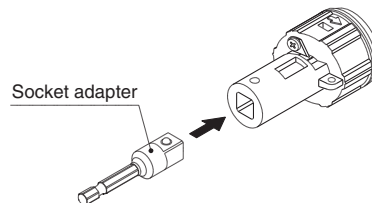

Adjustment of cutter and stripping length is unnecessary

A constant stripping length is always possible due to the fixed cutter with angle that cuts until the tube reaches the end surface inside the stripper.

Removal of stripped tube is unnecessary.

Since the stripped tube is discharged to the outside, no additional labor is required to remove it.

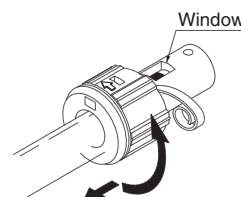



TKS Series Specific Product Precautions

Be sure to read this before handling the products.

Operation

⚠ Caution

1. Insert the tube into the double layer tube stripper (TKS series).

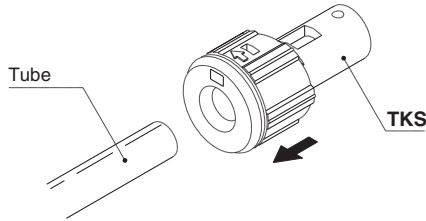

2. Rotate the TKS in the arrow direction while pushing it.
3. Strip the outer layer until the cut end of the tubing strikes the end surface inside the stripper.

The end surface can be confirmed in the window.

Note) Stripping is not possible by rotating in the opposite direction.

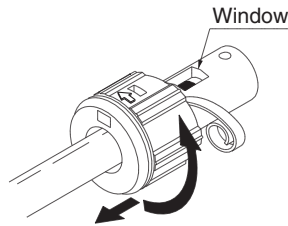

4. Pull the TKS off of the tubing to complete stripping.
The tube can be attached as it is to a FR One-touch fitting.

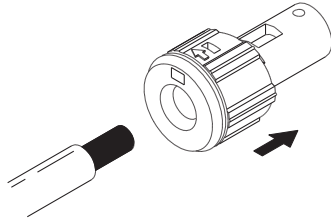

Attachment to Tools

⚠ Caution

1. Align the socket of the TKS with a commercially available male socket adapter (9.5 mm square).
2. Connect the socket adapter to the TKS.

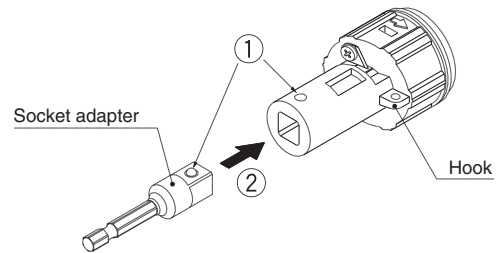

3. Connection with tools such as an air driver is also possible.
Note) Ensure the TKS does not shake or vibrate.

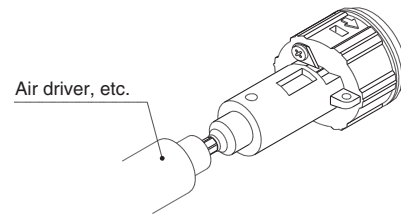

Operation

⚠ Caution

1. When using a tool such as air driver, use a push-start type which rotates after the tubing is inserted.
2. Do not insert the tube when the TKS is rotating, as the pawl may be damaged.

Related Products: Tube Releasing Tool *TG Series*



- It is possible to detach the tube from the one-touch fitting one-handed.
- Suitable for use in small spaces where it is difficult to get your hands in.
- One tool is compatible with two different tubing sizes. (Refer to “Size change” below.)

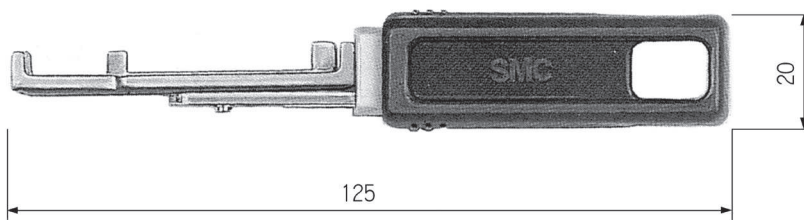

Model	Applicable tubing size		Applicable tubing material	Colour	Weight
TG-1	Metric size	Ø 4, Ø 6	Nylon, Soft nylon Polyurethane	Blue	33 g
TG-2	Inch size	Ø 1/8", Ø 1/4"		Red	

How to Use

⚠ Caution

Process

1. Tool edge should be pushed straightforward into the edge of the release button along with the tube in the axial fitting direction.

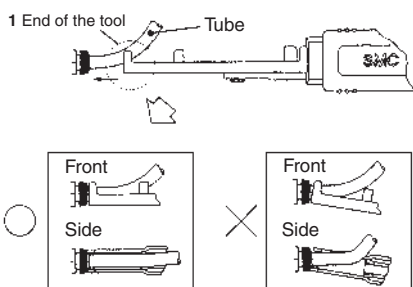

2. After inserting, grasp the handle tightly and insert the end of the tubing to the stroke end.

[Note) Insert firmly to the guard against an accidental tube release.]

3. After inserting end of tube, relax your grip on the tool. Returning force of spring releases the tube.

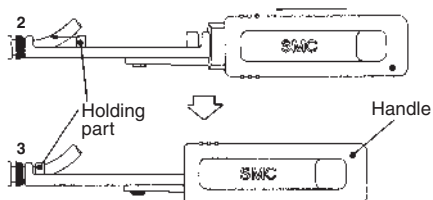

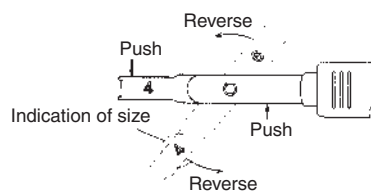

Size change

Push both sides at once to release. Reverse and fix at the same position as before. Applicable tube size is indicated on the back side.



Safety Instructions

These safety instructions are intended to prevent hazardous situations and/or equipment damage. These instructions indicate the level of potential hazard with the labels of “Caution,” “Warning” or “Danger.” They are all important notes for safety and must be followed in addition to International Standards (ISO/IEC)¹⁾, and other safety regulations.

-  **Caution:** **Caution** indicates a hazard with a low level of risk which, if not avoided, could result in minor or moderate injury.
-  **Warning:** **Warning** indicates a hazard with a medium level of risk which, if not avoided, could result in death or serious injury.
-  **Danger:** **Danger** indicates a hazard with a high level of risk which, if not avoided, will result in death or serious injury.

- 1) ISO 4414: Pneumatic fluid power – General rules relating to systems.
ISO 4413: Hydraulic fluid power – General rules relating to systems.
IEC 60204-1: Safety of machinery – Electrical equipment of machines.
(Part 1: General requirements)
ISO 10218-1: Manipulating industrial robots - Safety.
etc.

Warning

1. The compatibility of the product is the responsibility of the person who designs the equipment or decides its specifications.

Since the product specified here is used under various operating conditions, its compatibility with specific equipment must be decided by the person who designs the equipment or decides its specifications based on necessary analysis and test results. The expected performance and safety assurance of the equipment will be the responsibility of the person who has determined its compatibility with the product. This person should also continuously review all specifications of the product referring to its latest catalogue information, with a view to giving due consideration to any possibility of equipment failure when configuring the equipment.

2. Only personnel with appropriate training should operate machinery and equipment.

The product specified here may become unsafe if handled incorrectly. The assembly, operation and maintenance of machines or equipment including our products must be performed by an operator who is appropriately trained and experienced.

3. Do not service or attempt to remove product and machinery/equipment until safety is confirmed.

1. The inspection and maintenance of machinery/equipment should only be performed after measures to prevent falling or runaway of the driven objects have been confirmed.
2. When the product is to be removed, confirm that the safety measures as mentioned above are implemented and the power from any appropriate source is cut, and read and understand the specific product precautions of all relevant products carefully.
3. Before machinery/equipment is restarted, take measures to prevent unexpected operation and malfunction.

4. Contact SMC beforehand and take special consideration of safety measures if the product is to be used in any of the following conditions.

1. Conditions and environments outside of the given specifications, or use outdoors or in a place exposed to direct sunlight.
2. Installation on equipment in conjunction with atomic energy, railways, air navigation, space, shipping, vehicles, military, medical treatment, combustion and recreation, or equipment in contact with food and beverages, emergency stop circuits, clutch and brake circuits in press applications, safety equipment or other applications unsuitable for the standard specifications described in the product catalogue.
3. An application which could have negative effects on people, property, or animals requiring special safety analysis.
4. Use in an interlock circuit, which requires the provision of double interlock for possible failure by using a mechanical protective function, and periodical checks to confirm proper operation.

Caution

1. The product is provided for use in manufacturing industries.

The product herein described is basically provided for peaceful use in manufacturing industries. If considering using the product in other industries, consult SMC beforehand and exchange specifications or a contract if necessary. If anything is unclear, contact your nearest sales branch.

Limited warranty and Disclaimer/Compliance Requirements

The product used is subject to the following “Limited warranty and Disclaimer” and “Compliance Requirements”. Read and accept them before using the product.

Limited warranty and Disclaimer

1. The warranty period of the product is 1 year in service or 1.5 years after the product is delivered, whichever is first.²⁾ Also, the product may have specified durability, running distance or replacement parts. Please consult your nearest sales branch.
 2. For any failure or damage reported within the warranty period which is clearly our responsibility, a replacement product or necessary parts will be provided. This limited warranty applies only to our product independently, and not to any other damage incurred due to the failure of the product.
 3. Prior to using SMC products, please read and understand the warranty terms and disclaimers noted in the specified catalogue for the particular products.
- 2) Vacuum pads are excluded from this 1 year warranty.
A vacuum pad is a consumable part, so it is warranted for a year after it is delivered. Also, even within the warranty period, the wear of a product due to the use of the vacuum pad or failure due to the deterioration of rubber material are not covered by the limited warranty.

Compliance Requirements

1. The use of SMC products with production equipment for the manufacture of weapons of mass destruction (WMD) or any other weapon is strictly prohibited.
2. The exports of SMC products or technology from one country to another are governed by the relevant security laws and regulations of the countries involved in the transaction. Prior to the shipment of a SMC product to another country, assure that all local rules governing that export are known and followed.

Caution

SMC products are not intended for use as instruments for legal metrology.

Measurement instruments that SMC manufactures or sells have not been qualified by type approval tests relevant to the metrology (measurement) laws of each country. Therefore, SMC products cannot be used for business or certification ordained by the metrology (measurement) laws of each country.

Safety Instructions

Be sure to read “Handling Precautions for SMC Products” (M-E03-3) before using.

SMC Corporation (Europe)

Austria	+43 (0)2262622800	www.smc.at	office@smc.at
Belgium	+32 (0)33551464	www.smc.be	info@smc.be
Bulgaria	+359 (0)2807670	www.smc.bg	office@smc.bg
Croatia	+385 (0)13707288	www.smc.hr	office@smc.hr
Czech Republic	+420 541424611	www.smc.cz	office@smc.cz
Denmark	+45 70252900	www.smc.dk.com	smc@smcdk.com
Estonia	+372 651 0370	www.smcee.ee	info@smcee.ee
Finland	+358 207513513	www.smc.fi	smcfi@smc.fi
France	+33 (0)164761000	www.smc-france.fr	supportclient@smc-france.fr
Germany	+49 (0)61034020	www.smc.de	info@smc.de
Greece	+30 210 2717265	www.smchellas.gr	sales@smchellas.gr
Hungary	+36 23513000	www.smc.hu	office@smc.hu
Ireland	+353 (0)14039000	www.smcautomation.ie	sales@smcautomation.ie
Italy	+39 03990691	www.smcitalia.it	mailbox@smcitalia.it
Latvia	+371 67817700	www.smc.lv	info@smc.lv

Lithuania	+370 5 2308118	www.smclt.lt	info@smclt.lt
Netherlands	+31 (0)205318888	www.smc.nl	info@smc.nl
Norway	+47 67129020	www.smc-norge.no	post@smc-norge.no
Poland	+48 222119600	www.smc.pl	office@smc.pl
Portugal	+351 214724500	www.smc.eu	apoioclientept@smc.smces.es
Romania	+40 213205111	www.smcromania.ro	smcromania@smcromania.ro
Russia	+7 (812)3036600	www.smc.eu	sales@smcru.com
Slovakia	+421 (0)413213212	www.smc.sk	office@smc.sk
Slovenia	+386 (0)73885412	www.smc.si	office@smc.si
Spain	+34 945184100	www.smc.eu	post@smc.smces.es
Sweden	+46 (0)86031240	www.smc.nu	smc@smc.nu
Switzerland	+41 (0)523963131	www.smc.ch	info@smc.ch
Turkey	+90 212 489 0 440	www.smcturkey.com.tr	satis@smcturkey.com.tr
UK	+44 (0)845 121 5122	www.smc.uk	sales@smc.uk

South Africa +27 10 900 1233 www.smcza.co.za zasales@smcza.co.za