

FEP Tubing (Fluoropolymer)

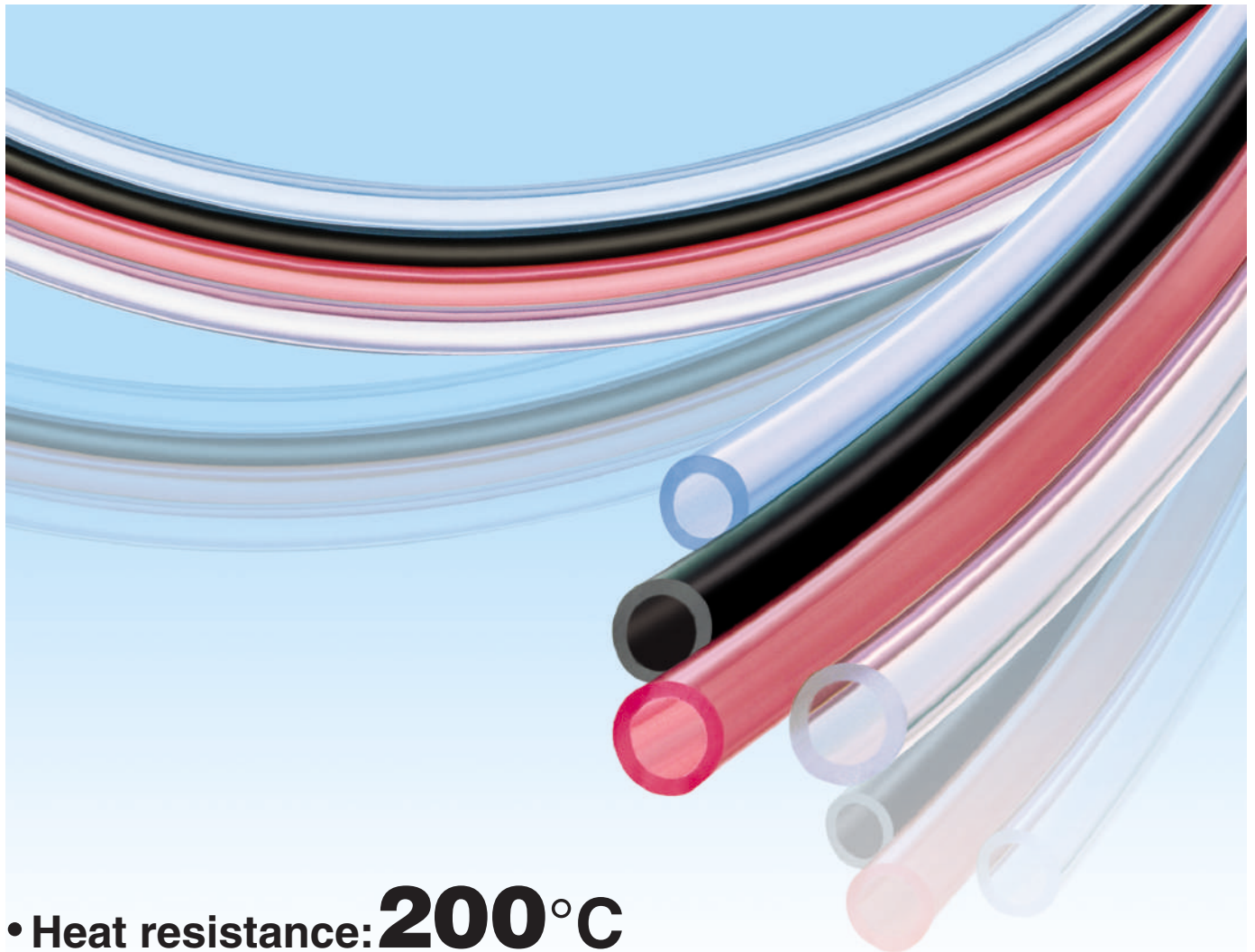

- **Heat resistance: 200°C**
It changes according to the operating pressure.
Refer to the graph of the max. operating pressures on page 1.

- **4 Colour variations**



- **8 Size variations**

Metric size: $\varnothing 4$ to $\varnothing 12$

- **Applicable fittings**
One-touch fittings (Series KQ2,KJ)
Miniature fittings (Series M,MS) (Hose nipple type)
Insert fittings (Series KF)
High Purity Fluoropolymer fittings (Series LQ)

Series TH

- **Applications**

General pneumatic piping

(Food
Semiconductor
Medical care
Automobile)

- **Certified to current Food Sanitation Legislation**

(Ministry of Japanese Health and
Safety, directive #370,1959)

FEP Tubing (Fluoropolymer) Metric Size Series TH

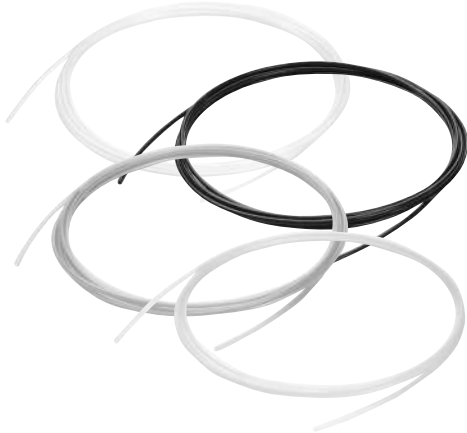

Operating Temperature: Max. 200°C
It varies depending on the operating pressure. Refer to the graph for the maximum operating pressure.

Compatible with the Food Sanitation Law

- Compatible with the test conforming to the Food Sanitation Law based on the 370th notice given by the Ministry of Health and Welfare in 1959.
- Compatible with the §177-1550 dissolution test approved by FDA (Food and Drug Administration).

Flame resistant (Equivalent to UL-94 Standard V-0)

How to measure the minimum bending radius.

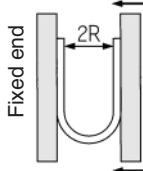

At a temperature of 20°C, bend the tubing into a U shape. Fix one end and gradually move the other end closer. Measure 2R at the point where the outside diameter's rate of change is 5%.

Max. Operating Pressure

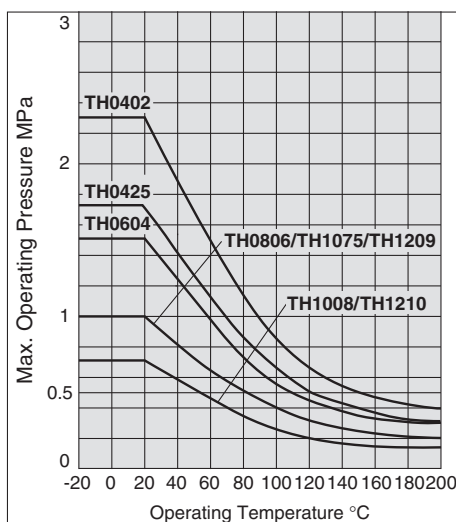

Note) The maximum operating pressure varies dependant on the I.D. bore size even if the O.D. is the same.

Series

●-20 m roll □-100 m roll

Model	Metric size							
	TH0402	TH0425	TH0604	TH0806	TH1075	TH1008	TH1209	TH1210
Tubing O.D. (mm)	4	4	6	8	10	10	12	12
Tubing I.D. (mm)	2	2.5	4	6	7.5	8	9	10

Color	Symbol	Inch nominal size							
Translucent	N	5/32"				5/16"			
Red (Translucent)	R	●	●	●	●	●	●	●	●
Blue (Translucent)	BU	●	●	●	●	●	●	●	●
Black (Opaque)	B	●	●	●	●	●	●	●	●

Specifications

Fluid	Air, Water ^{Note 1)} , Inert gas							
Applicable fittings ^{Note 2)}	One-touch fittings, Insert fittings Fluoropolymer fittings: LQ series ^{Note 3)} Miniature fittings: M, MS series (Hose nipple type)							
Max. operating pressure (MPa)	20°C	2.3	1.7	1.5	1	0.7	1	0.7
	100°C	0.85	0.6	0.55	0.4	0.25	0.4	0.25
	200°C	0.4	0.3	0.3	0.2	0.1	0.2	0.1
Refer to the max. operating pressure curve.								
Min. bending radius (mm) ^{Note 4)}	Recommended radius	15	20	35	60	95	100	130
	Tube close bend radius	10	15	20	40	60	65	110
Operating temperature	Air, Inert gas: -20 to 200°C Water: 0 to 100°C (No freezing)							
Material	FEP (Fluorinated Ethylene Propylene Resin)							

Note 1) When using a fluid in liquid form, the surge pressure must not exceed the maximum operating pressure. A surge pressure higher than the maximum operating pressure can cause breakage of the fittings, or rupture of the tubing.

Furthermore, an abnormal temperature increase due to adiabatic compression can also result in ruptured tubing.

Note 2) Do not use in locations where the FEP tubing will move.

Be sure to operate under the maximum operating pressure conditions using the lower maximum operating specification of either the tubing or fittings.

After long term use or under high temperatures, some fittings leakage may occur due to material deterioration with age. Perform periodic inspections, and if any leakage is detected, replace with a new product immediately. When the insert and miniature fittings are used over extended periods of time, it may cause leakage due to the material deterioration of age. In such a case, give an additional tightening to the tube connection part. If leakage still occurs after giving an additional tightening, replace the fitting with a new product. For other precautions, refer to "Fittings & Tubing Precautions" in Best Pneumatics No. 7. When using the fluoropolymer fittings, refer to the precautions on pages 71 and 72. Select the size after confirming O.D. and I.D.

Note 3) TH0402, TH0425, TH1075 and TH1209 are not available because of different internal diameters.

Note 4) The minimum bending radius is the representative value measured as shown in the left figure.

- Use a tube above the recommended minimum bending radius.
- The tubing may be bent if used under the recommended minimum bending radius. Therefore, refer to the tube close bend radius and make sure that the tubing is not bent or flattened.
- Please note that the tube close bend radius is not warranted because of the value when 2R is measured by the method in the left figure if the tubing is bent or flattened, etc.

How to Order

Metric size
TH0604 N - 20

Indication of tubing model ● Color indication ● Length per roll ●

Symbol	Color
N	Translucent
R	Red (Translucent)
BU	Blue (Translucent)
B	Black (Opaque)

Symbol	Roll size
20	20 m roll
100 ^{Note)}	100 m roll

Note) 100 m roll is available with translucent (color indication: N) only.

TH Series

Made to Order

(Please contact SMC for specifications in detail, dimensions, delivery and specifications other than those mentioned above.)

Reinforced corrugated cardboard specification longer length reel

ø6, Translucent only: Suffix "-X64" to the end of part number. Ex.) TH0604N-500-X64

Made to Order Availability

Part no.	Length	Model	TH0604N	Color
X64	250 m reel		○	Translucent
	500 m reel		○	

Reinforced corrugated cardboard specification: Longer length reel/-X64

Dimensions

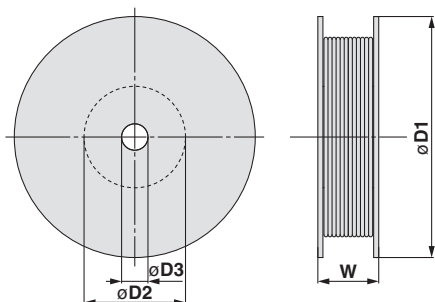

Dimensions

Model	øD1	øD2	øD3	W	Weight (kg)
TH0604N-250-X64	475	200	52	120	9.4
TH0604N-500-X64	475	200	52	220	18.5



Chemical Resistance of the Fluoropolymer FEP Material

Chemicals in this table are inactive against FEP material ^{Note 1)}, however physical properties may be effected by temperature or pressure change.

Please make sure that operating conditions do not cause problems since the use of FEP tubing under chemical environment is unsecured.

2-nitro-2-methyl propanol 2-nitrobutanol Pentabasic benzamide N-butylamine N-octadecanol N-butyl acetate O-cresol Di-isobutyl adipate Acetophenone Acetone Aniline Abietic acid Sulphuric chloride Isooctane Liquid ammonia Ethyl alcohol Ethyl ether Ethylene glycol Ethylenediamine Zinc chloride Aluminum chloride Ammonium chloride Calcium chloride Sulphuric chloride Iron chloride (III) Benzoyl chloride Magnesium chloride Hydrochloric acid Chlorine (absolute) Aqua regia Ozone Hydrogen peroxide Natrium peroxide Gasoline Permanganate Formic acid Xylene Chromic acid Chlorosulfonic acid Chloroform Paraffinum liquidum Allyl acetate Ethyl acetate Potassium Butyl acetate	Sodium hypochlorite Carbon tetrachloride Dioxane Cyclohexanone Cyclohexane Dimethyl ether Dimethylsulfoxide Dimethylformamide Bromine Deionized water Nitric acid Mercury Ammonium hydroxide Potassium hydroxide Sodium hydroxide Cetane Soap, detergent Dibutyl sebacate Diethyl carbonate Tetrachloroethylene Tetrahydrofuran Tetrabromoethane Triethanolamine Trichloroethylene Trichloroacetic acid Toluene Naphtha Naphthalene Naphthol Lead Carbon dioxide Nitrogen dioxide Nitrobenzene Nitromethane Perchloroethylene Perphloroxylyene Unsymmetrical dimethylhydrazine Hydrazine Pinene Piperidine Glacial acetic acid (Acetic acid) Pyridine Phenol Phthalic acid Dybutyl phthalate	Dimethyl phthalate Hydrofluoric acid Naphthalene fluoride Nitrobenzene fluoride Furan Hexachlorethane Hexane Ethyl hexanoate Phenylcarbinol Benzaldehyde Benzonitrile Borax Boric acid Formic aldehyde (Formalin) Acrylic anhydride Acetic anhydride Methacrylic acid Allyl methacrylate Vinyl methacrylate Methyl alcohol Methyl ethyl ketone Methylene chloride Sulphuric acid Phosphoric acid Iron phosphate (III) Tri-n-butyl phosphate Tricresyl phosphate
--------------------------------------------------------------------------------------------------------------------------------------------------------------------------------------------------------------------------------------------------------------------------------------------------------------------------------------------------------------------------------------------------------------------------------------------------------------------------------------------------------------------------------------------------------------------------------------------------------------------------------------------------------------------------------------------------------------------------------------------------------------------------------------------------------------------------------	----------------------------------------------------------------------------------------------------------------------------------------------------------------------------------------------------------------------------------------------------------------------------------------------------------------------------------------------------------------------------------------------------------------------------------------------------------------------------------------------------------------------------------------------------------------------------------------------------------------------------------------------------------------------------------------------------------------------------------------------------------------------------------------------------------------------------------	-----------------------------------------------------------------------------------------------------------------------------------------------------------------------------------------------------------------------------------------------------------------------------------------------------------------------------------------------------------------------------------------------------------------------------------------------------------------------------------------------------------------------------------------------

Note 1) "Chemically inert" means – not to cause any chemical reaction.

Note 2) The data above is based on the information presented by the material manufacturers.

Note 3) The applicable fluid list provides reference values as a guide only, therefore we do not guarantee the application to our product.

Note 4) SMC is not responsible for its accuracy and any damage happened because of this data.

Reference cited: Teflon®, the fluoropolymer handbook, Manual for the chemical applications of Teflon®. Du Pond-Mitsui Fluorochemicals Co., Ltd.

Teflon® is a registered trademark for the fluoropolymer produced by E.I du Pond de Nemours & Company (Inc.) and Du Pond-Mitsui Fluorochemicals Co., Ltd.



Series TH Safety Instructions

These safety instructions are intended to prevent a hazardous situation and/or equipment damage. These instructions indicate the level of potential hazard by a label of "**Caution**", "**Warning**" or "**Danger**". To ensure safety, be sure to observe ISO 4414 ^{Note 1)}, JIS B 8370 ^{Note 2)} and other safety practices.

 **Caution** : Operator error could result in injury or equipment damage.

 **Warning** : Operator error could result in serious injury or loss of life.

 **Danger** : In extreme conditions, there is a possible result of serious injury or loss of life.

Note 1) ISO 4414: Pneumatic fluid power – General rules relating to systems

Note 2) JIS B 8370: Pneumatic system axiom

Warning

1. The compatibility of pneumatic equipment is the responsibility of the person who designs the pneumatic system or decides its specifications.

Since the products specified here are used in various operating conditions, their compatibility with the specific pneumatic system must be based on specifications or after analysis and/or tests to meet your specific requirements. The expected performance and safety assurance will be the responsibility of the person who has determined the compatibility of the system. This person should continuously review the suitability of all items specified, referring to the latest catalogue information with a view to giving due consideration to any possibility of equipment failure when configuring a system.

2. Only trained personnel should operate pneumatically operated machinery and equipment.

Compressed air can be dangerous if handled incorrectly. Assembly, handling or maintenance of pneumatic systems should be performed by trained and experienced operators.

3. Do not service machinery/equipment or attempt to remove components until safety is confirmed.

1. Inspection and maintenance of machinery/equipment should only be performed once measures to prevent falling or runaway of the driven object have been confirmed.
2. When equipment is to be removed, confirm the safety process as mentioned above. Cut the supply pressure for this equipment and exhaust all residual compressed air in the system.
3. Before machinery/equipment is restarted, take measures to prevent shooting-out of cylinder piston rod, etc.

4. Contact SMC if the product is to be used in any of the following conditions:

1. Conditions and environments beyond the given specifications, or if product is used outdoors.
2. Installation on equipment in conjunction with atomic energy, railway, air navigation, vehicles, medical equipment, food and beverages, recreation equipment, emergency stop circuits, clutch and brake circuit in press applications, or safety equipment.
3. An application which has the possibility of having negative effects on people, property, or animals, requiring special safety analysis.



Series TH Tubing Precautions

Be sure to read before handling. Refer to page 3 for Safety Instructions.

Selection

Warning

1. Confirm the specifications.

The products appearing in this catalogue are designed for use only in compressed air systems (including vacuum).

Do not use outside the specified ranges of pressure, temperature, etc., as this may cause damage or malfunction. (Refer to specifications.)

SMC cannot assure the product quality when fluids other than air, water and inert gas are used.

Consult with SMC for details.

2. In case of using the product for medical care

This product is designed for use with compressed air system applications for medical care purposes. Do not use in contact with human bodily fluids, body tissues or transfer applications to a human living body.

Caution

1. Do not use in locations where the connecting threads and tubing connection will slide or rotate. The connecting threads and tubing connection will come apart under these conditions.

Use rotary type one-touch fittings (Series KS, KX) in cases where sliding or rotation will occur. Only air can be used as the operating fluid, when using rotary type one-touch fittings.

2. Use tubing at or above the minimum bending radius. Using below the minimum bending radius can cause breakage or flattening of the tubing.
3. Never use the tubing for anything flammable, explosive or toxic such as, gas, fuel gas, or cooling mediums, since the contents can penetrate outward.

Mounting

Caution

1. Before mounting confirm the model and size, etc. Also, confirm that there are no blemishes, nicks or cracks in the product.
2. When tubing is connected, consider factors such as changes in the tubing length due to pressure, and allow sufficient leeway.
3. Mount so that fittings and tubing are not subjected to twisting, pulling or moment loads. This can cause damage to fittings and flattening, bursting or disconnection of tubing, etc.
4. Mount so that tubing is not damaged due to tangling and abrasion. This can cause flattening, bursting or disconnection of tubing, etc.

Piping

Caution

1. Preparation before piping

Before piping is connected, it should be thoroughly blown out with air (flushing) or washed to remove chips, cutting oil and other debris from inside the pipe. Do not allow chips of the piping thread or the seal material to go in.

Air Supply

Warning

1. Types of fluid

This product is designed for use with compressed air. Consult SMC if a different fluid is to be used.

Consult SMC regarding products for use with general purpose fluids, to confirm which fluids can be used.

2. When there is a large amount of drainage.

Compressed air containing a large amount of drainage can cause the malfunction of pneumatic equipment. An air dryer or Drain Catch should be installed upstream from filters.

3. Drain management

If air filter drains are not flushed regularly, the drainage will flow downstream leading to the malfunction of pneumatic equipment.

In cases where the management of drain flushing will be difficult, the use of filters with automatic drains is recommended.

For details on the quality of compressed air mentioned above, refer to SMC's "Best Pneumatics" catalogue vol. 4.

Operating Environment

Warning

1. Do not operate in locations in an explosive atmosphere.
2. Do not operate in locations where vibration or impact occurs.
3. In locations near heat resources, block off radiant heat.

Maintenance

Caution

1. Check for the following during regular maintenance, and replace components as necessary.
 - a) Scratches, gouges, abrasion, corrosion
 - b) Leakage
 - c) Twisting, flattening or distortion of tubing
 - d) Hardening, deterioration or softness of tubing
2. Do not repair or patch the replaced tubing or fittings for reuse.
3. When using insert or miniature fittings over a long period, some leakage may occur due to age deterioration of the materials. Perform periodic inspections, and if any leakage is detected, correct the problem by additional tightening. If tightening becomes ineffective, replace the fittings with a new product immediately.



EUROPEAN SUBSIDIARIES:



Austria

SMC Pneumatik GmbH (Austria).
Girakstrasse 8, A-2100 Korneuburg
Phone: +43 2262-62280, Fax: +43 2262-62285
E-mail: office@smc.at
<http://www.smc.at>



France

SMC Pneumatique, S.A.
1, Boulevard de Strasbourg, Parc Gustave Eiffel
Bussy Saint Georges
F-77607 Marne La Vallee Cedex 3
Phone: 01-6476 1000, Fax: 01-6476 1010
<http://www.smc-france.fr>



Lithuania

UAB Ottensten Lietuva
Savanoriu pr. 180, LT-2600 Vilnius, Lithuania
Phone/Fax: 370-2651602



Slovakia

SMC Priemyselna Automatizacia, s.r.o.
Námestie Martina Benku 10
SK-81 107 Bratislava
Phone: +421 2 444 56725, Fax: +421 2 444 56028
E-mail: office@smc.sk
<http://www.smc.sk>



Belgium

SMC Pneumatics N.V./S.A.
Nijverheidsstraat 20, B-2160 Wommelgem
Phone: 03-355-1464, Fax: 03-355-1466
E-mail: post@smcpneumatics.be



Germany

SMC Pneumatik GmbH
Boschring 13-15, D-63329 Egelsbach
Phone: 06103-4020, Fax: 06103-402139
E-mail: info@smc-pneumatik.de
<http://www.smc-pneumatik.de>



Netherlands

SMC Pneumatics BV
De Ruyterkade 120, NL-1011 AB Amsterdam
Phone: 020-5318888, Fax: 020-5318880
E-mail: info@smcpneumatics.nl



Slovenia

SMC industrijska Avtomatika d.o.o.
Grajski trg 15, SLO-8360 Zuzemberk
Phone: +386 738 85240 Fax: +386 738 85249
E-mail: office@smc-ind-avtom.si
<http://www.smc-ind-avtom.si>



Bulgaria

SMC Industrial Automation Bulgaria o.o.d.
Vitinia str., bl. 89, entr. V app. 41, BG-1517 Sofia
Phone: +359 2 9744492, Fax: +359 2 9744519
E-mail: sales@smc.at
<http://www.smc.bg>



Greece

S. Parianopoulos S.A.
7, Konstantinoupoleos Street,
GR-11855 Athens
Phone: 01-3426076, Fax: 01-3455578



Norway

SMC Pneumatics Norway A/S
Vollsveien 13 C, Granfos Næringspark
N-1366 Lysaker
Tel: (47) 67 12 90 20, Fax: (47) 67 12 90 21
<http://www.smc-norge.no>



Spain

SMC España, S.A.
Zuazobidea 14
01015 Vitoria
Phone: 945-184 100, Fax: 945-184 124
E-mail: post@smc.smces.es



Czech Republic

SMC Industrial Automation CZ s.r.o.
Hudcova 78a, CZ-61200 Brno
Phone: +420 5 414 24611, Fax: +420 5 412 18034
E-mail: office@smc.cz
<http://www.smc.cz>



Hungary

SMC Hungary Ipari Automatizálási Kft.
Budafoki út 107-113, H-1117 Budapest
Phone: +36 1 371 1343, Fax: +36 1 371 1344
E-mail: office@smc-automation.hu
<http://www.smc-automation.hu>



Poland

SMC Industrial Automation Polska Sp.z.o.o.
ul. Konstruktorska 11A, PL-02-673 Warszawa,
Phone: +48 22 548 5085, Fax: +48 22 548 5087
E-mail: office@smc.pl
<http://www.smc.pl>



Sweden

SMC Pneumatics Sweden AB
Ekhagsvägen 29-31, S-141 71 Huddinge
Phone: 08-603 07 00, Fax: 08-603 07 10
<http://www.smc.nu>



Denmark

SMC Pneumatik A/S
Knudsminde 4B, DK-8300 Odder
Phone: (45)70252900, Fax: (45)70252901
E-mail: smc@smc-pneumatik.dk



Ireland

SMC Pneumatics (Ireland) Ltd.
2002 Citywest Business Campus,
Naas Road, Saggart, Co. Dublin
Phone: 01-403 9000, Fax: 01-464-0500



Portugal

SMC Sucursal Portugal, S.A.
Rua de Engº Ferreira Dias 452, 4100-246 Porto
Phone: 22-610-89-22, Fax: 22-610-89-36
E-mail: postpt@smc.smces.es



Switzerland

SMC Pneumatik AG
Dorfstrasse 7, CH-8484 Weisslingen
Phone: 052-396-3131, Fax: 052-396-3191
E-mail: info@smc.ch
<http://www.smc.ch>



Estonia

SMC Pneumatics Estonia OÜ
Laki 12-101, 106 21 Tallinn
Phone: 06 593540, Fax: 06 593541
<http://www.smcpneumatics.ee>



Italy

SMC Italia S.p.A
Via Garibaldi 62, I-20061 Carugate, (Milano)
Phone: 02-92711, Fax: 02-9271365
E-mail: mailbox@smcitalia.it
<http://www.smcitalia.it>



Romania

SMC Romania srl
Str. Frunzei 29, Sector 2, Bucharest
Phone: 01-324-2626, Fax: 01-324-2627
E-mail: smccadm@canad.ro
<http://www.smcromania.ro>



Turkey

Entek Pnömatik San. ve Tic Ltd. Sti.
Perpa Tic. Merkezi Kat: 11 No: 1625,
TR-80270 Okmeydanı Istanbul
Phone: 0212-221-1512, Fax: 0212-221-1519
<http://www.entek.com.tr>



Finland

SMC Pneumatics Finland OY
PL72, Tiistinnityntie 4, SF-02031 ESPOO
Phone: 09-859 580, Fax: 09-8595 8595
<http://www.smcfitec.sci.fi>



Latvia

SMC Pneumatics Latvia SIA
Smerla 1-705, Riga LV-1006, Latvia
Phone: 0777-94-74, Fax: 0777-94-75
<http://www.smclv.lv>



Russia

SMC Pneumatik LLC.
36/40 Sredny pr. St. Petersburg 199004
Phone: (812) 118 5445, Fax: (812) 118 5449
E-mail: smcfa@peterlink.ru
<http://www.smc-pneumatik.ru>



UK

SMC Pneumatics (UK) Ltd
Vincent Avenue, Crownhill,
Milton Keynes, MK8 0AN
Phone: 0800 1382930 Fax: 01908-555064
E-mail: sales@smcpneumatics.co.uk
<http://www.smcpneumatics.co.uk>



OTHER SUBSIDIARIES WORLDWIDE:

ARGENTINA, AUSTRALIA, BOLIVIA, BRASIL, CANADA, CHILE, CHINA, HONG KONG, INDIA, MALAYSIA, MEXICO, NEW ZEALAND, PHILIPPINES, SINGAPORE, SOUTH KOREA, TAIWAN, THAILAND, USA, VENEZUELA

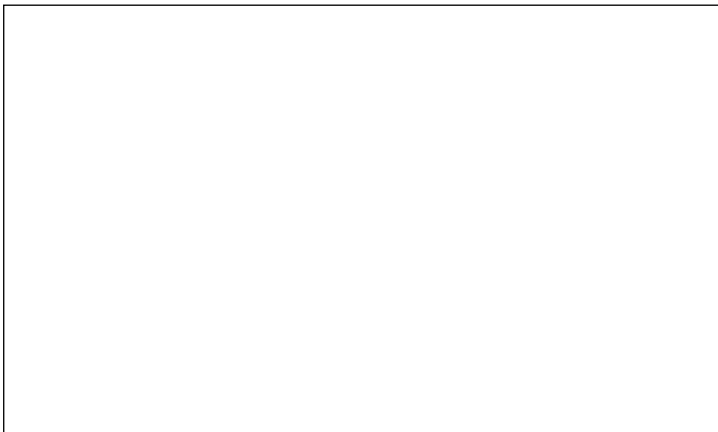

<http://www.smceu.com>
<http://www.smcworld.com>