

AS*2F, Speed Controller, One-touch Fitting, In-line, Compact AS3002F-10

Datasheet

Using SMC speed controllers with built in one-touch fittings minimizes installation time, reduces mounting height and enables a more compact machine design. These speed controllers allow the body to be rotated to facilitate simple installation. Available in thread sizes from M3 to 1/2 in both inch (NPT) and metric R(PT) and with tube sizes from 3.2mm to 12mm OD (metric) and 1/8 to 1/2 OD (inch) and with optional elbow and universal style (increased flexibility) and meter in and meter out, these flow controls are designed to meet most applications.

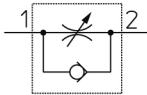

Flow control valve, adjustable, with reverse free flow

Standard specifications

Body Size	300 (3/8 Standard)
Applicable Tube O.D.	10 (ø10)
Option	None
Lock Nut	Standard (Hexagon)
Pressure medium	Compressed air
Maximum temperature of pressure medium	60 °C
Minimum temperature of pressure medium	-5 °C [without condensation]
Maximum operating pressure	1.0 MPa
F007-MIN_OP_PRESSURE	0.1 MPa
Proof pressure	1.5 MPa
Maximum ambient temperature	60 °C
Minimum ambient temperature	-5 °C
Conform to the European RoHS Directive	Conform
Numero of pneumatic connections	2 pcs.
Pneumatic input connection	Ø 10 mm
Pneumatic output connection	Ø 10 mm
Function of Flow control valve	Throttle valve
Flow rate	920 NI/min
Usable tubing material	Nylon

Weight

0.042 Kg

Dimensions

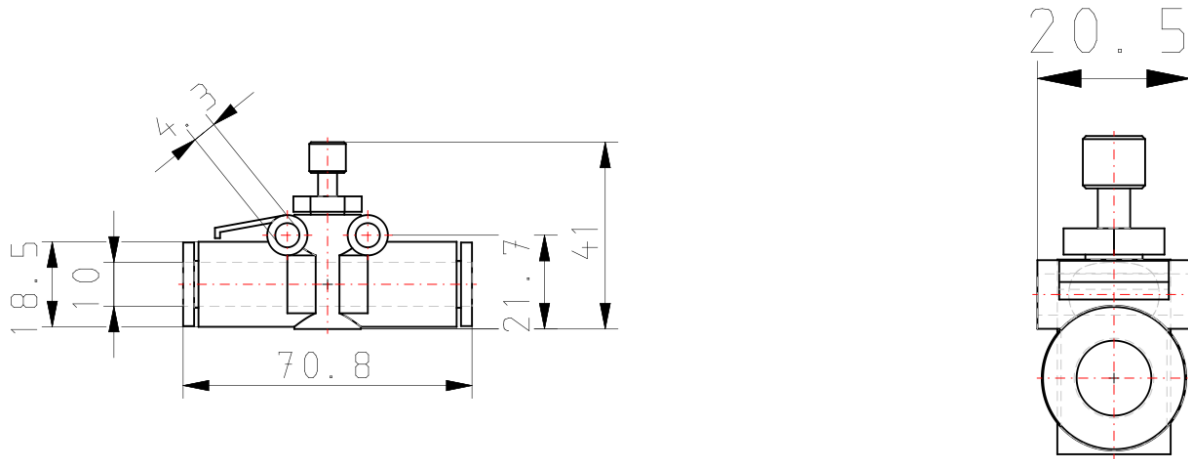

Constructions

AS1002F, AS2002F, AS2052F

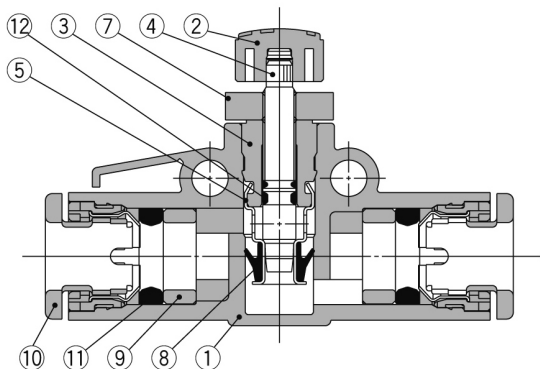

Component Parts

No.	Description	Material	Note
1	Body A	PBT	
2	Handle	PBT	
3	Body B	Brass	Electroless nickel plated
4	Needle	Brass	Electroless nickel plated
5	Seat ring	Brass	Electroless nickel plated
6	Needle guide	Brass	Electroless nickel plated

AS1002F-02, AS3002F, AS4002F

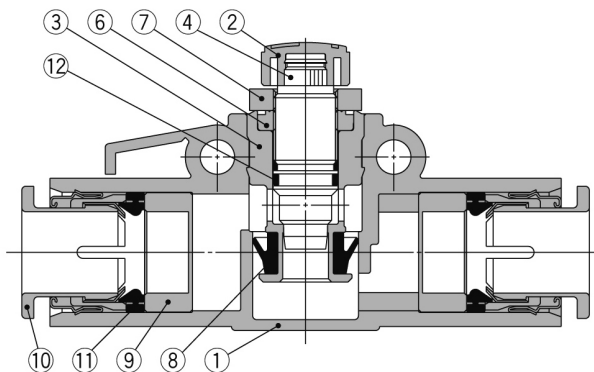

No.	Description	Material	Note
7	Lock nut	Steel wire	Zinc chromated
8	U-seal	HNBR	
9	Spacer	POM ^{Note)}	
10	Cassette	—	
11	Seal	NBR	
12	O-ring	NBR	

Note) AS2052F, AS3002F, AS4002F are made of PBT. AS3002F-11, AS4002F-11, AS4002F-13 are made of electroless nickel plated brass.

Additional information

Catalogue

[AS1002F-4002F-A_EU.pdf](#)