

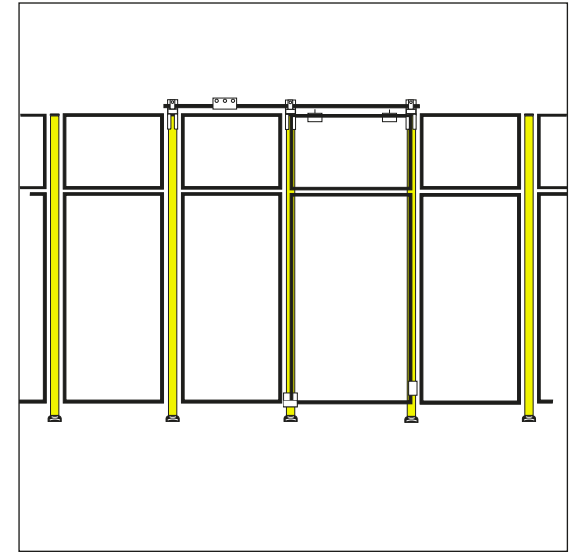

AXELENT X-GUARD D20-XXX140B



20130801

B20-2A
x 3



x 1 A x 4 B x 1 C x 1 D

D3U1-230
x 1

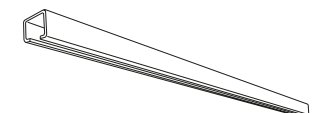

x 1 A

D3U1-075
x 1

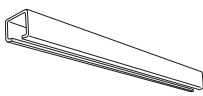

x 1 A

D3S-1
x 1

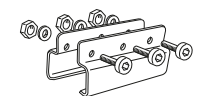

x 1 A

B20-2B
x 1

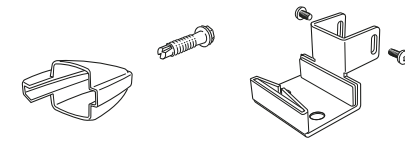

x 1 A x 1 B x 1 C

B20-2C
x 1

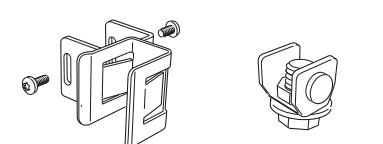

x 1 A x 2 B

D3U2-150
x 1

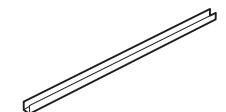

x 1 A

G2741
x 2

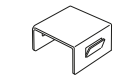

x 1 A

B00-010
x 1

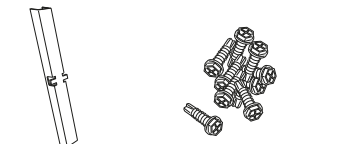

x 2 A x 1 B

B20-2K
x 2

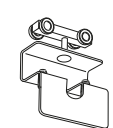

x 1 A

AXELENT X-GUARD D20-XXX140B

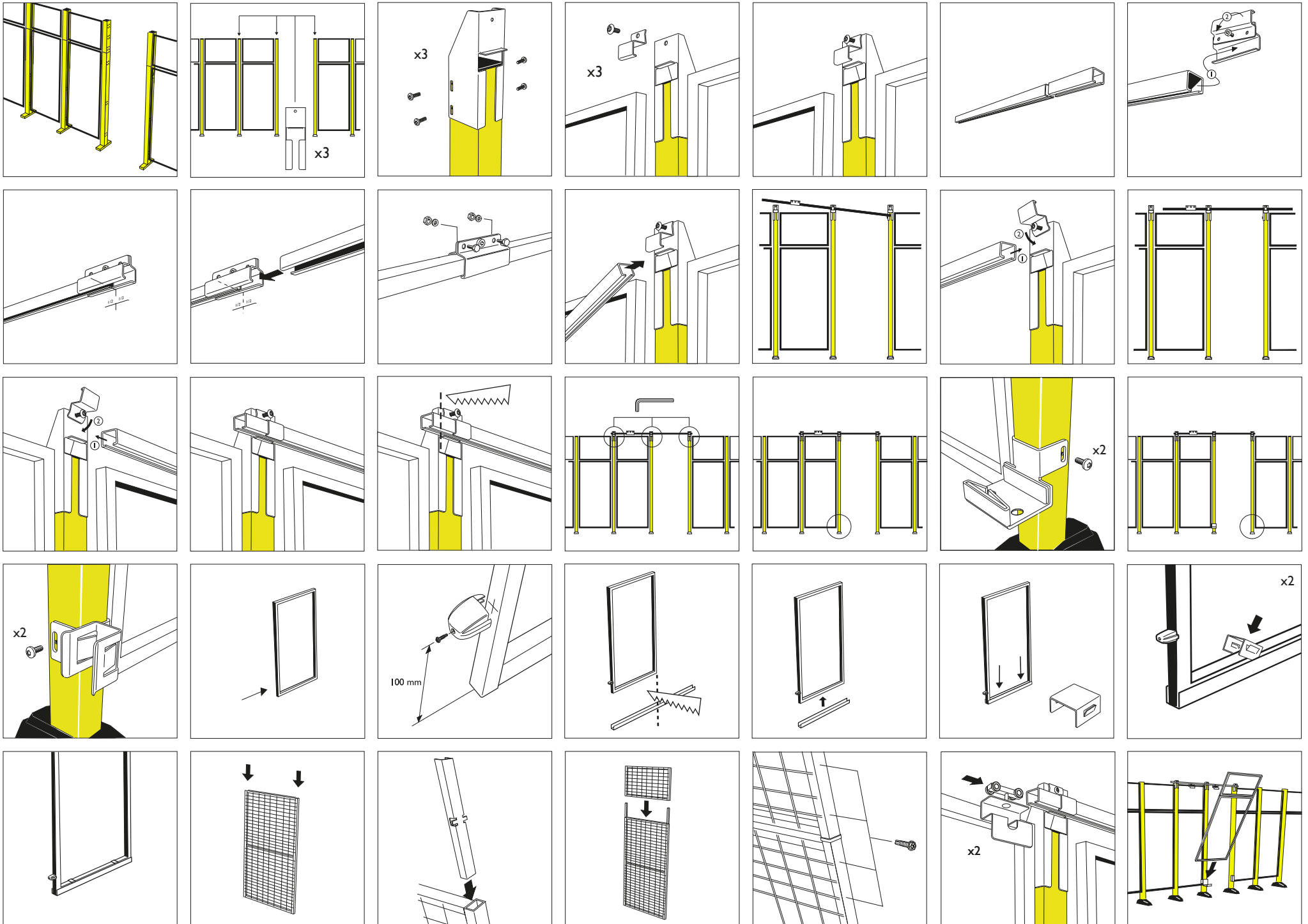

AXELENT X-GUARD D20-XXX140B

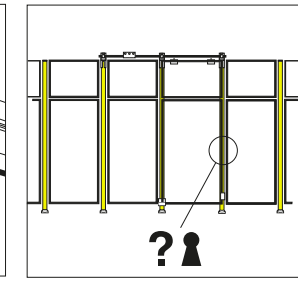
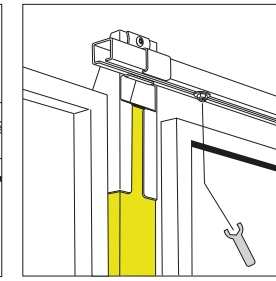
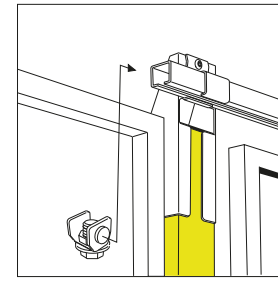
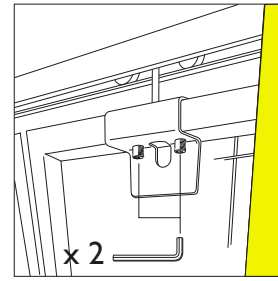
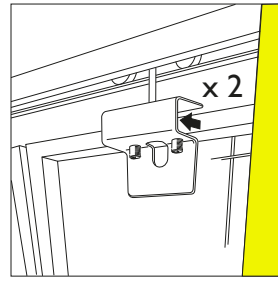
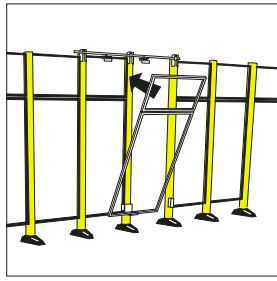
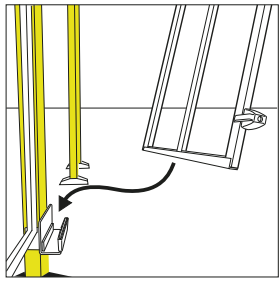

H G F E D C B A

3080

3134.5 ±5

3055

93.5

16

3.5

3

2300

A (1:5)

B (1:5)

10

109

16

100

157

Opening

1400

1

1530

Item No.	Name	Quantity
1	322-220150	2
2	P11-230	3
3	322-075150	2



Title
D20-XXX140B

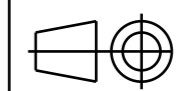

Scale
1:15

Rev.
--A

Date
4/9/2013

H G B A

4

4

3

3

2

2

1

1